

Professor Coggins installation and maintenance





1. Installation
 - 1.1 Unpacking
 - 1.2 Assembling
 - 1.3 Set up
2. Game operation
 - 2.1 Gun consoles
 - 2.2 Main cabinet
 - 2.3 Target descriptions
 - 2.3.1 Floating balls
 - 2.3.2 Fire extinguisher
 - 2.3.3 Skull Ed
 - 2.3.4 Tin can on Shelf
 - 2.3.5 Micro brain wave
 - 2.3.6 Pop up Robot
 - 2.3.7 Fusebox
 - 2.3.8 Monkey disco
 - 2.3.9 Spinning test tubes
 - 2.3.10 Anglepoise lamp
 - 2.3.11 Falling atomic ball
 - 2.3.12 Bio hazard alarm
 - 2.3.13 Atomiser eyes and mouth
 - 2.3.14 Bubbling liquids
3. Access
4. Maintenance
 - 4.1 No electrical power
 - 4.2 Unable to hit targets
5. Schematic drawing- gun board, timer module, sound module
6. Parts
7. Contacts

1. Installation

1.1 Unpacking

Carefully remove all packaging material, and site the machine on a flat and level floor. The machine is designed for indoor use only.

1.2 Assembling

Assemble by referring to the separate assembly manual part # PC056

1.3 Set up

The machine is delivered with the following settings:-

Coin mechanism £1 per game

Shots per game 20

Tickets per hit 1

Settings can be altered using the dip switches in the red housings in the following picture.

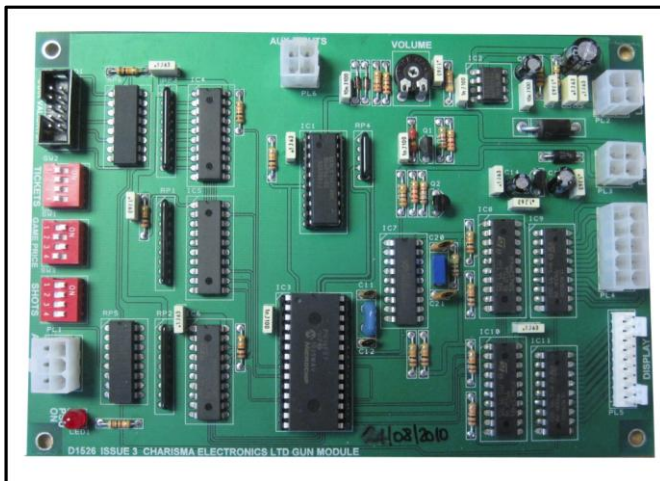

Turn Power Off Before Altering Dip Switches

1

Dip Switch Settings
Tickets Out
SW2 Dip Switch

Tickets	T1	T2	T3	T4
1 ticket	Off	Off	Off	Off
2 tickets	On	Off	Off	Off
3 tickets	Off	On	Off	Off
4 tickets	On	On	Off	Off
5 tickets	Off	Off	On	Off
6 tickets	On	Off	On	Off
7 tickets	Off	On	On	Off
8 tickets	On	On	On	Off
9 tickets	Off	Off	Off	On
10 tickets	On	Off	Off	On
11 tickets	Off	On	Off	On
12 tickets	On	On	Off	On
13 tickets	Off	Off	On	On
14 tickets	On	Off	On	On
15 tickets	Off	On	On	On
16 tickets	On	On	On	On

2

Dip Switch Settings
Price of Play
SW1 Dip Switch

Price	S1	S2	S3	S4
50p/EC	Off	Off	Off	Off
60p/EC	On	Off	Off	Off
70p/EC	Off	On	Off	Off
80p/EC	On	On	Off	Off
90p/EC	Off	Off	On	Off
100p/EC	On	Off	On	Off
110p/EC	Off	On	On	Off
120p/EC	On	On	On	Off
130p/EC	Off	Off	Off	On
140p/EC	On	Off	Off	On
150p/EC	Off	On	Off	On
160p/EC	On	On	Off	On
170p/EC	Off	Off	On	On
180p/EC	On	Off	On	On
190p/EC	Off	On	On	On
200p/EC	On	On	On	On

3

Dip Switch Settings
Shots per Game
SW3 Dip Switch

Shots	S1	S2	S3	S4
1 shot	Off	Off	Off	Off
2 shots	On	Off	Off	Off
4 shots	Off	On	Off	Off
6 shots	On	On	Off	Off
8 shots	Off	Off	On	Off
10 shots	On	Off	On	Off
12 shots	Off	On	On	Off
14 shots	On	On	On	Off
16 shots	Off	Off	Off	On
18 shots	On	Off	Off	On
20 shots	Off	On	Off	On
22 shots	On	On	Off	On
24 shots	Off	Off	On	On
26 shots	On	Off	On	On
28 shots	Off	On	On	On
30 shots	On	On	On	On

2. Game operation

2.1 Gun consoles

When a coin is inserted, and the gun trigger is squeezed, infra red light is emitted from the gun barrel.

2.2 Main Cabinet

Each target has an infra red detector, which senses a beam of light from the gun. The target operates a relay on the timer module, which in turn sends a signal to the target animation. The length of time a target operates is adjustable on the timer module, but this is factory set and should not need to be altered.

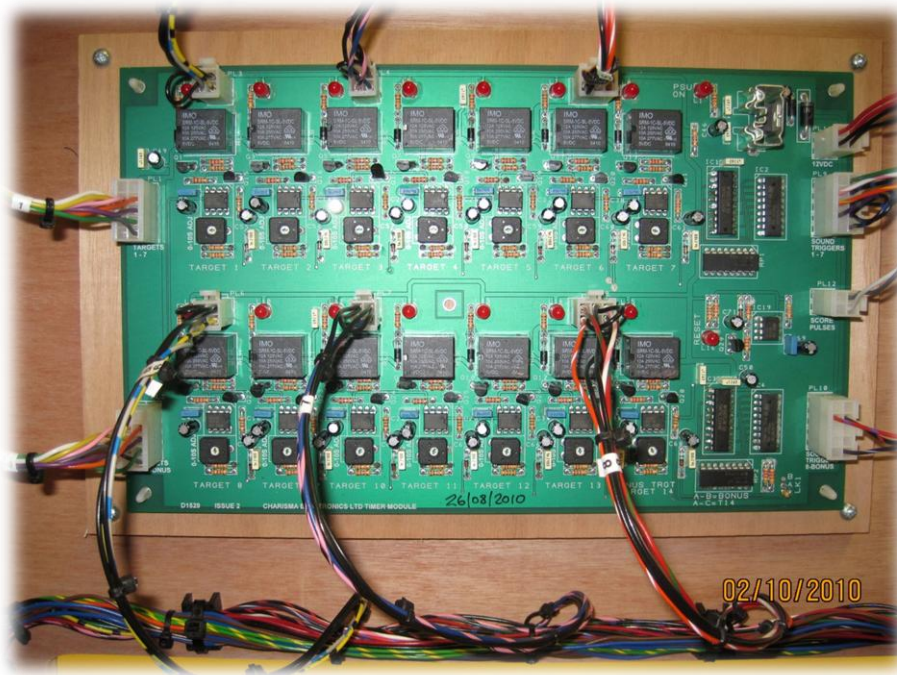

Timer module E704

2.3 Target Descriptions

2.3.1 Floating balls

The balls are operated by compressed air. A normally closed air valve is operated by a hit on the target box, which sends 12 volt dc to the valve coil, opens the valve and allows a flow of compressed air into the ball chamber.

2.3.2 Fire extinguisher



Hit the target and the extinguisher horn swings up, there is a sound effect and water squirts from under the bench top.

Access to the mechanism is by removing the 3 woodscrews pointed out with red arrows on the left picture.

2.3.3 Skull Ed

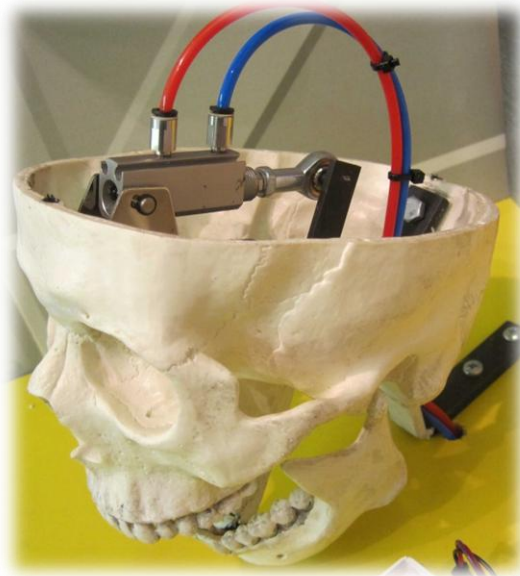

There is a sound effect and the jaw moves.

2.3.4 Tin can on shelf



An air blast blows the can up a wire

2.3.5 Micro brain wave

The cabinet interior lights up and a motor revolves the head. Sound effect.



2.3.6 Pop up robot



A cylinder lifts the robot into view, and it talks with different messages

2.3.7 Fusebox



An air cylinder opens the fusebox door, lights flash and there is a sound effect

2.3.8 Monkey Disco



Air cylinders open the left and right doors, the monkey moves from side to side using another air cylinder, loud music and lighting effects.

2.3.9 Spinning test tubes



A motor revolves the test tube holder, and the tubes lift up
Sound effect.

2.3.10 Anglepoise Lamp



An air cylinder lifts the arm, the lamp lights and turns towards the player

2.3.11 Falling atomic ball



A ball appears through the top hole, rolls down and disappears through the bottom hole.

The ball is lifted back to the top with an air cylinder.

2.3.12 Bio hazard alarm



The beacon lights and rotates with an alarm noise

2.3.13 Atomiser eyes and mouth



An air cylinder lifts the eye brows, and another air cylinder operates the mouth.

Multiple messages

2.3.14 Bubbling liquids



A lamp illuminates, and air is bubbled through the liquid

Bubbling noises

2. Access

3. The tubular cash door key will open all 3 cash doors. The flat key will open all the other doors. Gun consoles – Undo the 2 locks on the top face of the consoles, the top is hinged at the back, and will lift complete with the guns.



Coin doors – Opening the top door gives access to the coin mechanism, and opening the bottom door gives access to the cash box.

The rear side door allows access to the message repeater and electrical components.

4. Fault finding

4.1 No electrical power

Check the wall socket for a supply. Check the fuse in the plug, and in the machine rear socket where the power enters the machine.

If no power to the gun consoles, check the connections and wiring from the main cabinet to the consoles. Check the console power supply (in the consoles centre back) for a red light, and press the reset button next to the light.

If no power to one gun section, check the connections from the power supply, the connections on the gun board, and fuses.

4.2 Unable to hit targets

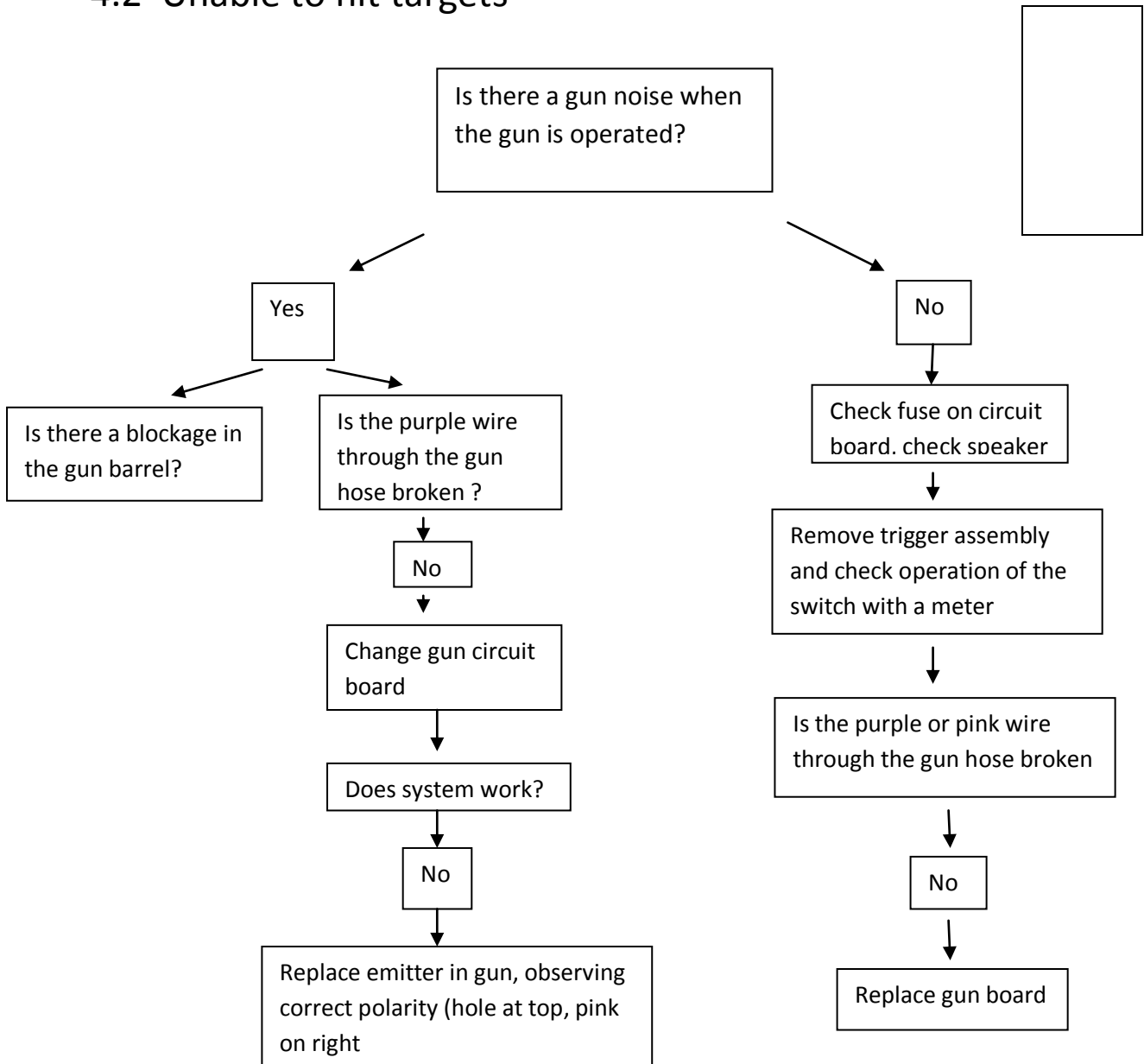

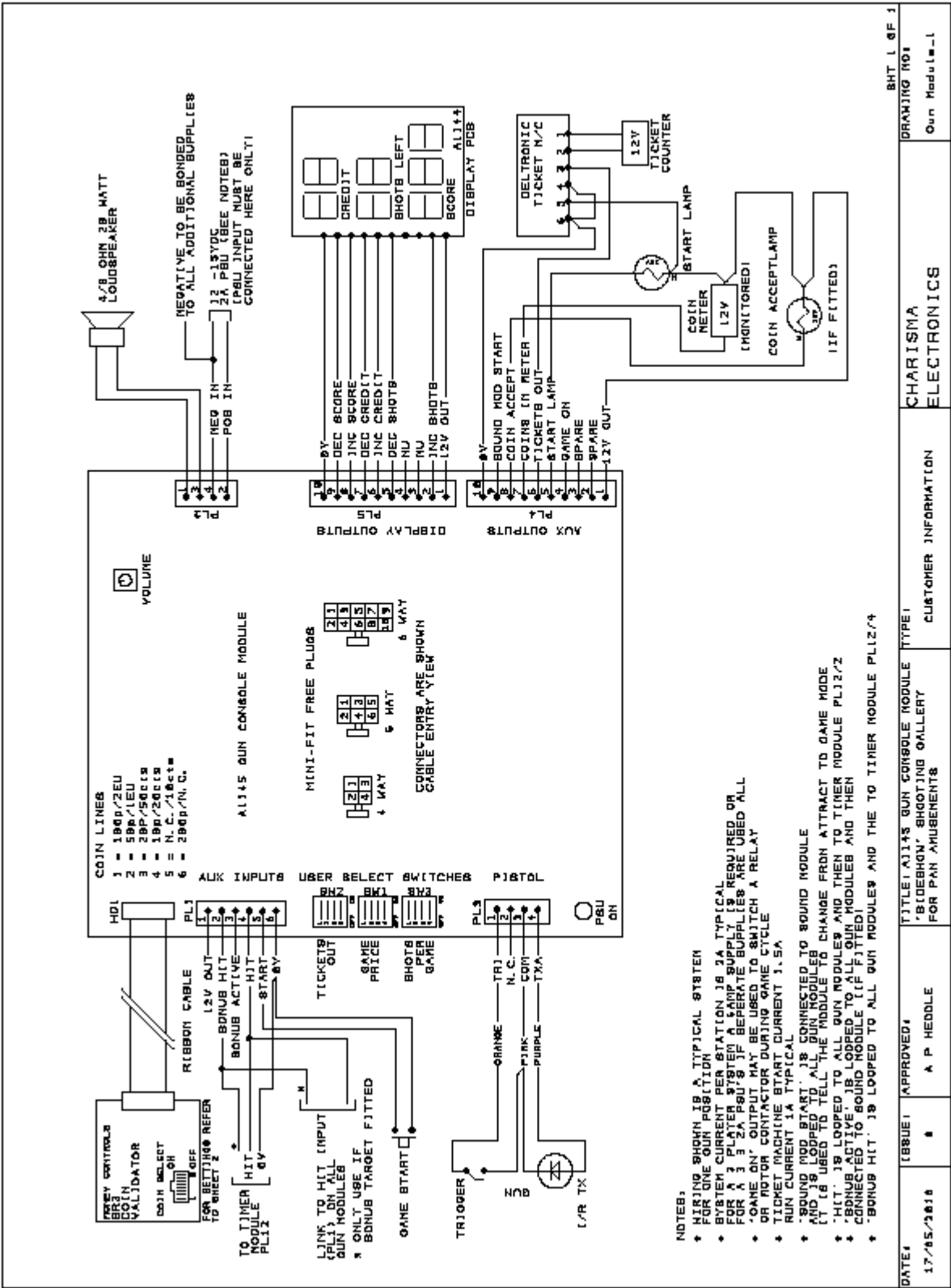

DATE:	17/05/2010	APPROVED:	A P HEDDLE	TITLE: ALL45 GUN CONSOLE MODULE TYPE1	CUSTOMER INFORMATION	CHARISMA ELECTRONICS	DRAWING NO:	Gun Module-1
-------	------------	-----------	------------	---------------------------------------	----------------------	----------------------	-------------	--------------

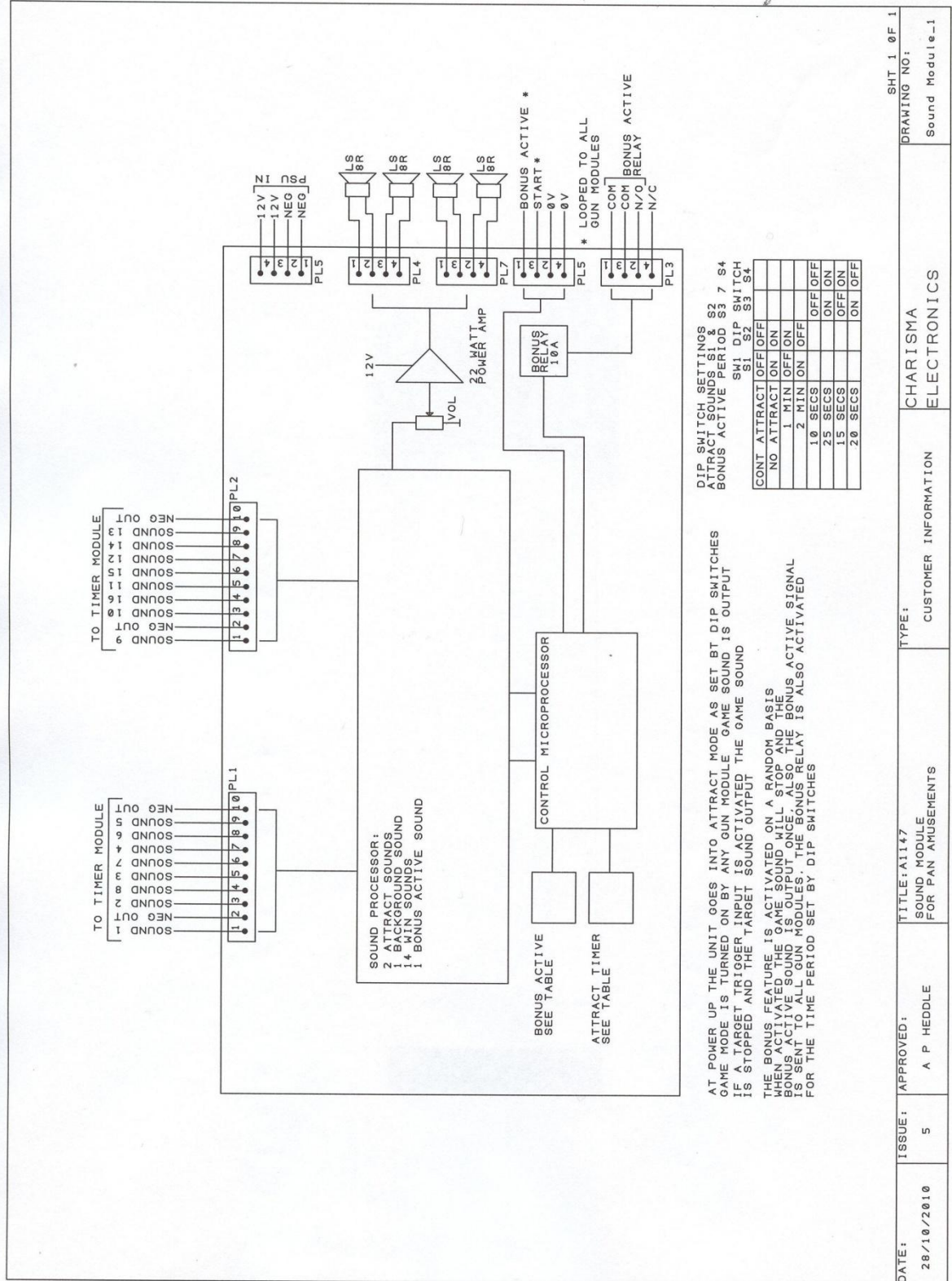

DATE: 28/10/2010

ISSUE: 5

APPROVED: A P HEDDLE

TITLE: A1147
 SOUND MODULE FOR PAN AMUSEMENTS

TYPE: CUSTOMER INFORMATION

CHARISMA ELECTRONICS

DRAWING NO.: Sound Module-1

SHT 1 OF 1

E706 sound module

Connected to timer module PL10

Connected to timer module PL9

Bonus active
Connected to gun modules PL1 pin 3

Start connected to gun modules PL4 pin 9

12 volt dc -
12 volt dc +

Loudspeaker

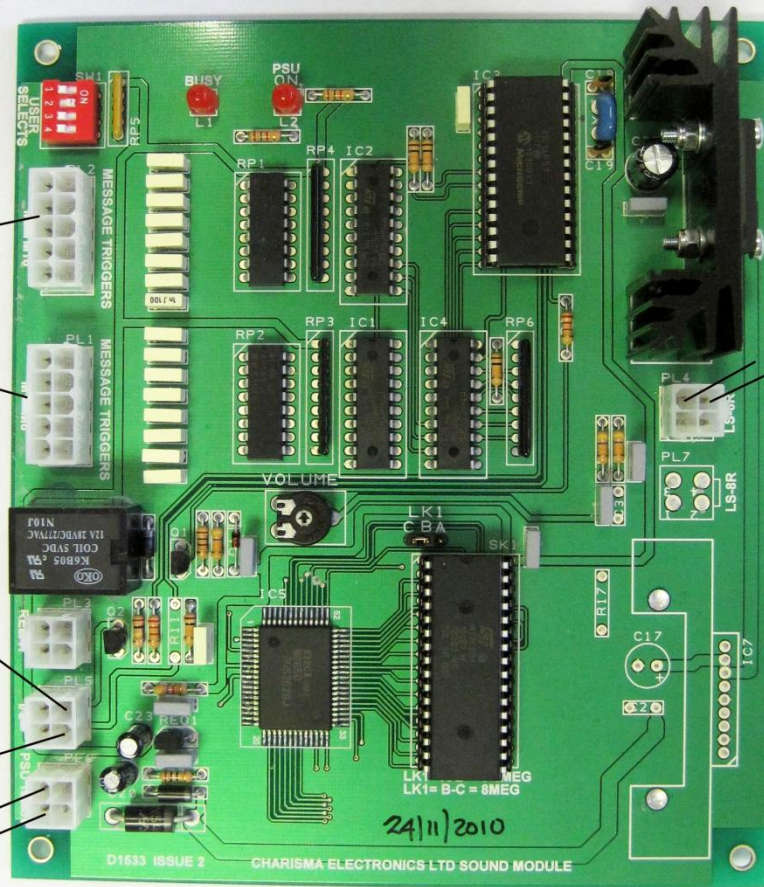

Control Board Rev. 8 DL-1275 with 12V meter output

This dispenser is controlled by the game software. The game turns on the dispenser with a logic high signal and monitors a return notch signal from the ticket dispenser to turn it off. It will dispense as many tickets as games options allow.

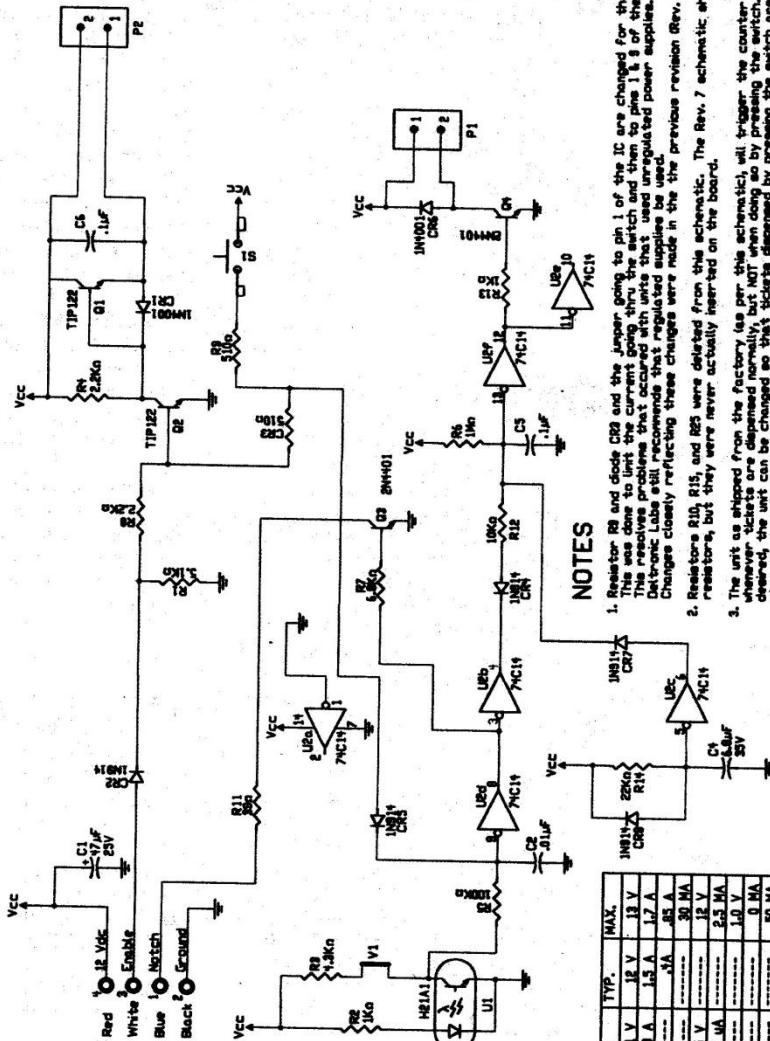

NOTES

- Resistor R8 and diode D28 and the jumper going to pin 1 of the IC are changed for this revision. This is done to limit the current going thru the switch and then to pins 1 & 9 of the IC. The schematic is shown with a resistor that used unregulated power supplies. Deltronic Labs still recommends that you use regulated power supplies. Changes closely reflecting these changes were made in the previous revision (Rev. 7).
- Resistors R10, R15, and R25 were deleted from the schematic. The Rev. 7 schematic shows these resistors, but they were never actually inserted on the board.
- The unit as shipped from the factory (as per the schematic), will trigger the counter whenever tickets are dispensed normally, but NOT when the counter is triggered by pressing the switch. If desired, the unit can be changed so that tickets dispensed by pressing the switch are also counted. Do this by deleting diode D28.
- This unit can be made to conform to CE specifications by the addition of 4 components not shown here. If this is desired, please order the CE version, and the unit will be shipped with the necessary components.
- This unit can be configured in a number of ways. Please check our "Full Options" schematic to see the different configurations. If this schematic is not included with your manual, contact us for a copy.
- If tickets are highly translucent, the 4.7kOhm resistor (R9) can be lowered in value (e.g., 2.2 kOhm). For more sensitive adjustment, the jumper J1 can be replaced with a 20k pot, and the 4.7 kOhm resistor (R9) changed to 10kOhm.

MOTOR SUPPLY - V	MIN.	TYP.	MAX.
I (START)	11 V	12 V	13 V
I (RUN)	1.3 A	1.5 A	1.7 A
I (STANDBY)
MOTOR ENABLE ON - V	2.5 V
MOTOR ENABLE OFF - V
TICKET NOTCH - I SINK
V PULL UP

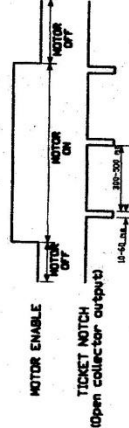

Control Board

Models DL-4-S-S DL-4-P-S

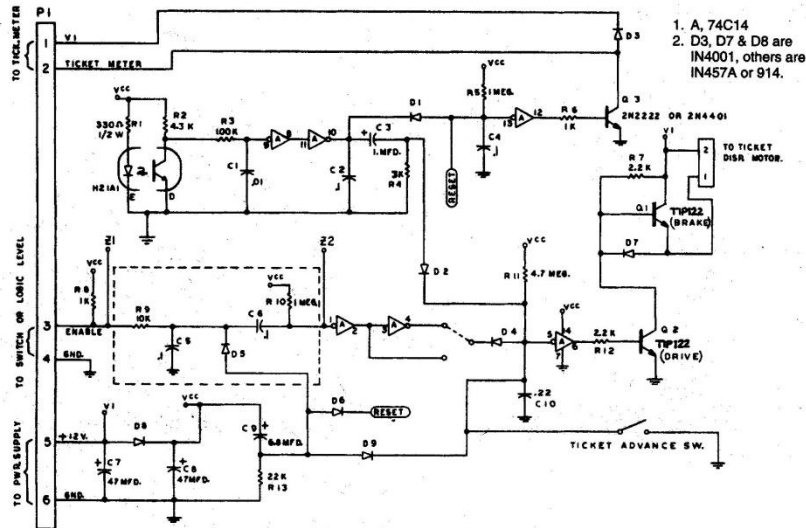

Model #DL-4-S-S, SW Input
 Model #DL-4-P-S, Logic Input.

Note: With logic input components and dotted lines are omitted and Z1 is jumpered to Z2.

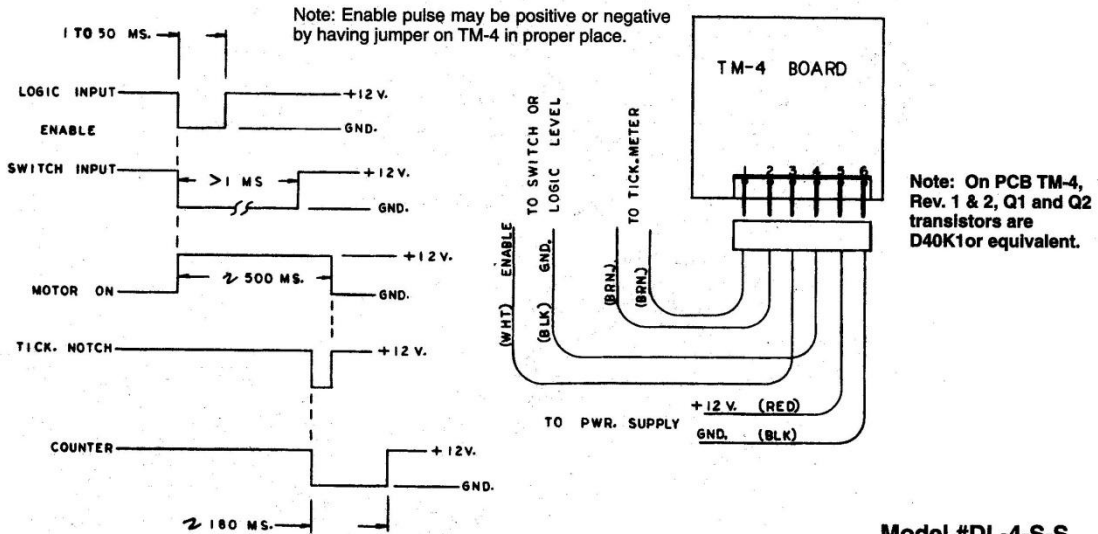

Note: On PCB TM-4, Rev. 1 & 2, Q1 and Q2 transistors are D40K1 or equivalent.

Model #DL-4-S-S
 Model #DL-4-P-S

Deltronic Labs, Inc. 120 Liberty Lane, Chalfont, PA 18914 • 215-997-8616 • FAX# 215-997-9506 • www.deltroniclabs.com

Ticket Dispenser Assembly

Details of Parts			
F/N	Qty	Deltronic Labs P/N	Name
11	1	SHFT-IDLR/LR/TD/	IDL. ROLLER SHAFT
12	1	RM-SFTMTR/TD/	MOTOR PIVOT SHAFT
13	1	SPAC PIVBLK/TD/4HOL	PIVOT BRACKET SPAC
14	1	RM-SPCPB/TD/	SPACER BLOCK
15	2	RM-RLRIDL/TD/VALD	IDLER ROLLER
16	1	RM-RLDRV/TD/VALD	DRIVE ROLLER
17	2	SPRG-TENSN/TD/	TENSION SPRING
18	2	RM-BKTPVT/TD/	MTR PIVOT BKT.
19	1	RM-PANLFT/TD/NOPM	FRONT PANEL
20	1	RM-WHLBRK/TD/	BRAKE WHEEL
21	1	SPRG-LOCAT/TD/	LOCATING SPRING
22	1	RM-BKTBRK/TD/	BRAKE BRACKET
23	1	RM-BKTUB/TD/3/8	URETHANE BRAKE
24	1	PCBD-1275/TD/*	PC BOARD
25	1	RM-MOTOR/TD/	MOTOR
26	2	RM-PLATFR/TD/	FRAME PLATE
27	1	RM-CONN2P/TD/20G	2-PIN FEMALE CONN.
28	4	BRNG-F312/T1/BRASS	BUSHING
29	1	SPAC-PCBD/TD/	P.C. BOARD SPACER
30	1	SPAC-HEX/TD/1-1/4	HEX SPACER 1-1/4"
31	1	RM-1M/T1/50V	.1MFD 50V
32	1	SPAC-HEX/TD/1/4"	STAND OFF
33	1	GUID-BOTTOM/TD/MET	LOWER GUIDE MET.
34	4	RING-E25RT/T1/	RETAINING RING
35	1	GUID-TOP/TD/MET	TOP GUIDE METAL
36	2	PULY-SP212/TEANYLN **	SPACER WASHER
37	2	SPRG-FRONTP/TD/	SPRING FRONT-PLATE
38	4	RM-PENMUT/TD/FRPL	PENMUT FRAME
39	2	RM-PENMUT/TD/FRPN	PENMUT FRONT
40	1	COVR-H21A/TD/OPTO	DUST COVER
41	1	CONN-MOLEX/TD/4PM	4 WIRE MOLEX MA.
42	1	RM-LABEL/TD/ALUM.	LABEL ALUMINUM
43	1	WIRE-REDBLK/TD/MOTOR	
44	2	SPAC-PIVBRK/TD/HEX***	SPACER 1/4" HEX.

* Order by Model #
 ** Note: F/N #36 replaces .032 and .093 spacer washers.
 *** Note: F/N #44 replaces large spacer block.

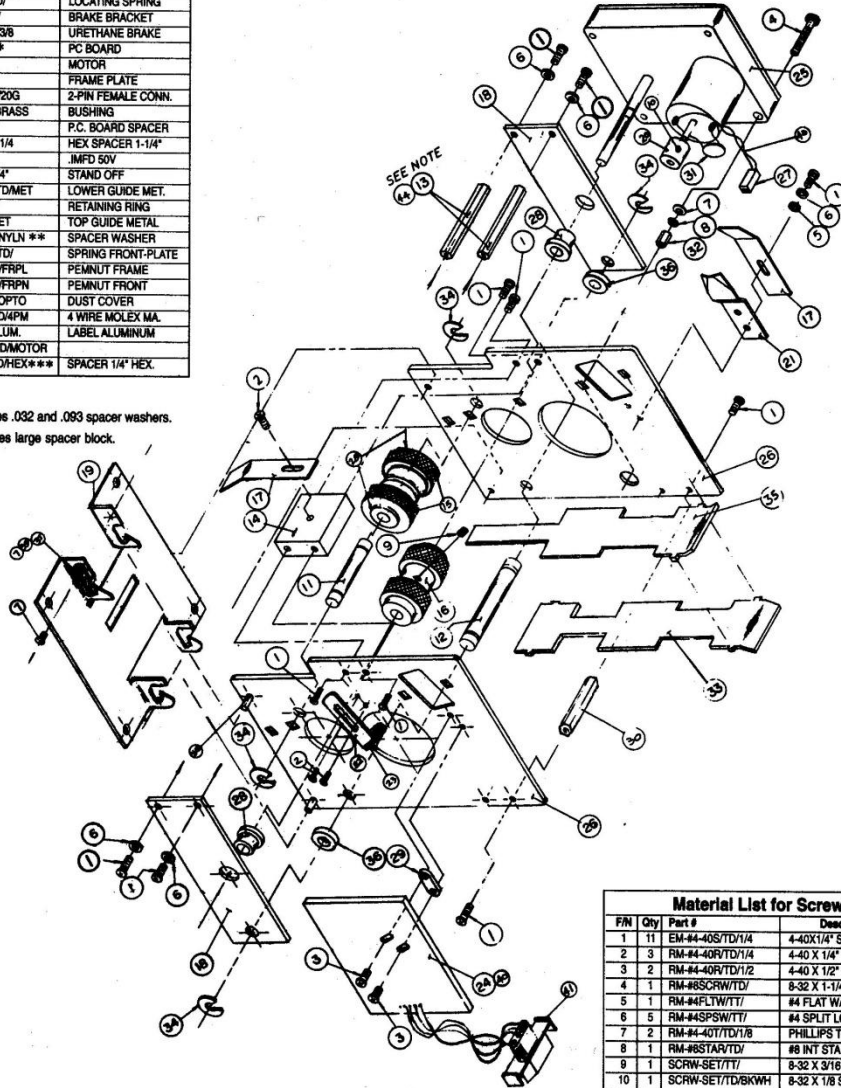

Material List for Screws			
F/N	Qty	Part #	Description
1	11	EM-44-40S/TD/1/4	4-40X1/4" SCREW
2	3	RM-44-40R/TD/1/4	4-40 X 1/4" WASHER HEAD
3	2	RM-44-40R/TD/1/2	4-40 X 1/2" WASHER HEAD
4	1	RM-48SCRW/TD/	8-32 X 1-1/4"
5	1	RM-44FLTW/T1/	#4 FLAT WASHER
6	5	RM-44SPSW/T1/	#4 SPLIT LOC. WASHER
7	2	RM-44-40T/TD/1/8	PHILLIPS TRUSSHEAD
8	1	RM-48STAR/TD/	#8 INT STAR WASHER
9	1	SCRW-SET/T1/	8-32 X 3/16" SET SCREW
10	1	SCRW-SET/TD/BKWH	8-32 X 1/8 SET SCREW

6 **Deltronic Labs, Inc.** 120 Liberty Lane, Chalfont, PA 18914 • 215-997-8616 • FAX# 215-997-9506 • www.deltroniclabs.com

1 Top Metal Ticket Guide

For servicing, the top metal ticket guide can be removed and replaced. With unit facing you, gently spread side plates with thumb and index finger. Tilt guide to right at 45° angle and snap left side tab out and pull straight back. When replacing, simply reverse these steps. Note there is no need to spread side plates while replacing guide. Tilt to right and insert right tab first.

Note: When PCB has opto-sensor cover, guide is inserted over sensor then directed down to right. Be sure guide is **BELOW** brake bracket screws when replaced.

2 Bottom Metal Ticket Guide

The longer, more durable ticket guide extends through the face plate allowing for better guidance plus a larger opening in the face plate prevents curled tickets from catching.

3 Loading of tickets with ticket advance switch

Tickets are inserted in the rear of machine between the top and bottom ticket guides and pushed forward to the rollers. If needed, gently push the locating spring (9) away from the ticket guides. Then push the ticket advance switch until you see the edge of first ticket.

4 Braking system

Our impressive new braking system eliminates brake slippage allowing foolproof, accurate dispensing. The new design also reduces wear and tear on the dispenser.

5 Brake bracket

The brake is easily accessible and can be adjusted to engage immediately when ticket is pulled. (Minimum of 1/8" from brake wheel.)

6 Opto-Sensor

Included as part of the controller is an opto-electronic beam sensor which detects the notch between tickets. The output of the ticket sensing circuitry is an open collector transistor.

7 Opto-Sensor Dust Cover

In addition, an optical sensor dust cover is also included to eliminate the possibility of ticket dust accumulating on the optical sensor. This increases the accuracy of the ticket count and reduces maintenance.

8 Roller Tension Spring

The roller tension springs keep constant tension on tickets which insures proper delivery and prevents the tickets from being "pulled through" when the dispenser is idle. To increase the tension, loosen the screw and move the spring forward. Tension is correctly adjusted when tickets cannot be pulled from the dispenser and validation rollers lightly emboss the tickets.

9 Locating Spring

The ticket guide spring insures that the notches in the tickets pass through the opto-sensor. To decrease tension, loosen the screw and move the outer tension spring up. This changes the tension on the inner spring. The tickets should be snug between the spring and the side plate but not deformed by the excess tension. The spring is adjusted at the factory for 1-5/32" wide tickets and positioned 1/8" from ticket guides.

10 "Quick Release" Face Plate

The dynamic new design allows the ticket dispenser to "quickly release" from its face plate on your cabinet or ticket door. This can be done manually and no tools are needed. This gives you complete access to the front of the rollers and to the ticket guides. Plus you can "snap out" one ticket dispenser and immediately replace it with another in just seconds.

11 Ticket Stop Adjustment

The ticket stop adjustment allows you to position the tickets while the machine is off. The tickets should protrude through the slot at least 1/16". The ticket dispenser PC board is mounted on spacer with two screws with washers in two slotted holes. Loosening the screws and moving the board forward will allow the tickets to stop further out beyond the edge of the slot.

Dispenser Specifications

The quick release face plate greatly improves serviceability and reduces maintenance. Now standard on all Deltronic Labs Ticket Dispensers.



- Low voltage operations, only 12V DC
- Solid state output allows interfacing with electronic games
- Compact size, only 3-1/8" W x 4" H x 5-1/2" L
- Weight: 2-1/4 lbs.
- Validation "diamond" mark identifies tickets that have been dispensed.
- Adjustable ticket stop
- Dispenses 2"L x 1-5/32"W tickets
- 4"L x 2"W ticket
- 4"L x 1-5/32"W ticket
- 2"L x 2"W duplex ticket
- One year warranty
- Standard face plate: 4"H x 3-3/4"W
- Narrow face plate: 4"H x 3-1/8"W
- 12V meter output
- CE (when requested)



Deltronic Labs, Inc.

120 Liberty Lane, Chalfont, PA 18914 • 215-997-8616 • FAX# 215-997-9506 • www.deltroniclabs.com

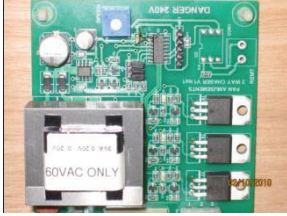

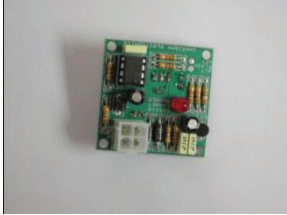
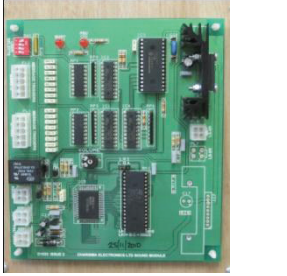
3

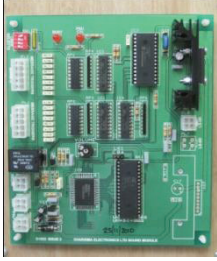
Professor Coggins machine parts are covered by a guarantee for 12 months from the date of delivery.

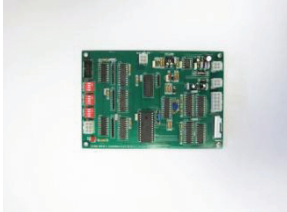
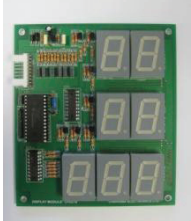

SD056D	Light chaser PCB	Controls light chaser, different features are available. See manual.	
SD056DREP	Light chaser PCB repair	REPAIR ONLY	AS ABOVE
E704	Timer module	Operated by the targets, switches motors and sound effects	
E704REP	Timer module repair	REPAIR ONLY	AS ABOVE
E702	Target module	Switched by infra red light from the gun	
E706	Sounds module	Generates the sound effects and the bonus feature	

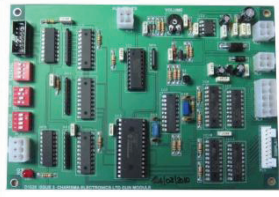
E706REP	Sound module repair	REPAIR ONLY	
E702B	Target box front plate		
SD069	Main cabinet speaker	Supplies sound effects from the main cabinet	
E701	Gun module	Counts shots, score, and generates infra red light	
			

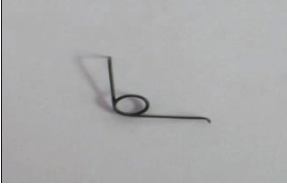
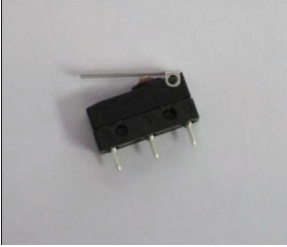
Gun consoles

E701	Gun module	Used in consoles to drive the gun system	
E701REP	Gun module repair	REPAIR ONLY	AS ABOVE
E703	Display module	Displays score, shots left, and credits remaining	
E703REP	Display module repair	REPAIR ONLY	AS ABOVE
G555	Small gun complete		
G708	Trigger torsion spring	Returns the trigger	
G710	Small gun micro switch	Operates the infra red sensor	

G416	Gun hose	Fastens the gun to the console	
G534	Gun hose plate	Provides a secure anchor for the gun to the console	
G020	Infra red emitter	Located on the trigger assembly. Sends infra red light to the target	
G018	Console gun hose ring	Fastened in the top of the console to allow the gun hose to pass through	
E129	Counter 12 volt DC	Used in consoles to count games played and tickets dispensed	
E152	Console speaker	Gun noise only	

H101	Flat key lock		
H106	Radial cash lock		

7.Contacts

Manufacturers :-Pan Amusements
Austerlands Mill
Huddersfield Road
Oldham, UK
OL4 3QB

Telephone 0161 652 8092
0161 624 5578
Fax 0161 627 5357
Email [info @panamusements.com](mailto:info@panamusements.com)
Website www.panamusements.com